

MAKE A WIND VANE

SUPPLIES

- PLASTIC CUP
- CARD STOCK
- SCISSORS
- PIN
- COMPASS
- SCOTCH TAPE
- STRAW
- PENCIL WITH AN ERASER

1 DRAW A SQUARE AND TWO TRIANGLES ONTO A PIECE OF CARD STOCK. THEN CUT THESE OUT

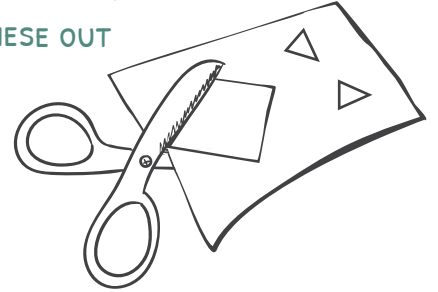

2 WRITE THE FOUR CARDINAL POINTS IN THIS ORDER
N (NORTH)
E (EAST)
S (SOUTH)
W (WEST)

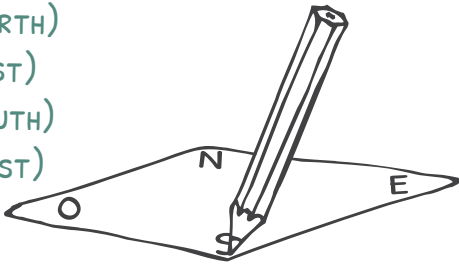

4 TAPE THE TWO TRIANGLES ONTO THE ENDS OF THE STRAW

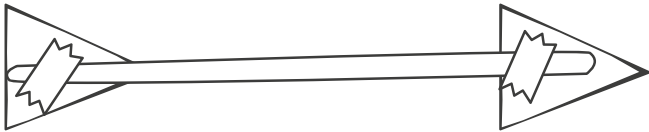

3 MAKE A HOLE IN THE CENTER OF BOTH THE SQUARE AND THE PLASTIC CUP USING THE PIN. NOW YOU CAN STICK THE PENCIL IN THE HOLES AS SEEN HERE.

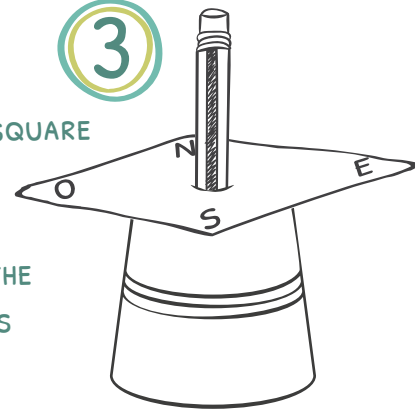

CHECK THAT THERE IS A BIT OF WIND TO TEST OUT YOUR WIND VANE

5 POKE THE PIN THROUGH THE CENTER OF THE STRAW AND THEN INTO THE TIP OF THE PENCIL'S ERASER

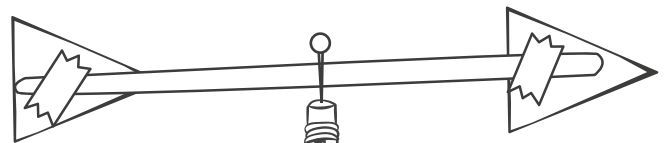

6 PLACE THE WIND VANE OUTSIDE WITH N POINTED TOWARDS NORTH AS INDICATED BY THE COMPASS

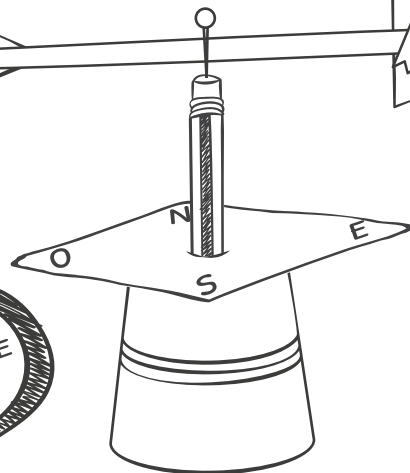
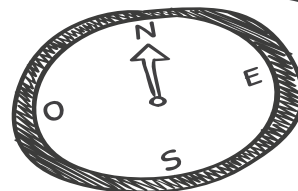

DO YOU SEE WHAT IS HAPPENING?

WOW !!!
THE ARROW INDICATES THE DIRECTION OF WHERE THE WIND IS COMING FROM